



Arne

URBIDERMIS TEAM, 2013

From many needs to numerous solutions. The Arne lighting system fits into any urban setting easily.

The Arne floodlight is a tribute to Danish design. Its clarity and versatility make it a fabulous lighting system for almost any type of urban or architectural space. Available in two sizes and with a wide range of fittings to be installed on a pole, catenary or the wall, as well as accessories for direct or indirect lighting. From multiple needs to accurate solutions, Arne floodlights fit efficiently into our everyday life.

De las muchas necesidades a las múltiples soluciones. El sistema de iluminación Arne se integra fácilmente en cualquier espacio urbano.

El proyector Arne rinde homenaje al diseño danés. Su claridad y versatilidad lo convierten en un magnífico sistema de iluminación para casi todo tipo de espacio urbano o arquitectónico. Disponible en dos tamaños, con una gran variedad de soportes, para instalación en columna, catenaria o pared, y con accesorios para iluminar de forma directa o indirecta. De las múltiples necesidades a las precisas soluciones, los proyectores Arne se integran de forma eficiente en nuestra vida cotidiana.



Plaza de las Glorias, Barcelona, Spain

Materials and finishes

Injected aluminium floodlight, primed and with Light grey, Medium grey or Dark grey paint finish. Stainless steel and injected aluminium accessories, primed and painted with same finish. Tempered optical glass diffuser. Poles made of hot-dip galvanised and primed steel, painted with the same finish: 4,40m, 5,20m and 6,00m heights, with one circular tube section of Ø 127 mm; 7,80m, 9,40m and 11,80m heights, with two circular tube sections of Ø 127 mm at the top and Ø 152 mm or Ø 168 mm at the bottom.

Materiales y acabados

Proyector de inyección de aluminio acabado imprimado y pintado Gris claro, Gris medio o Gris oscuro. Accesorios de acero inoxidable e inyección de aluminio acabados imprimados y pintados con el mismo color. Difusor de vidrio óptico templado. Columna de acero galvanizado en caliente imprimado y acabado pintado con el mismo color: de 4,40 m, 5,20 m, 6,00 m de altura, de un tramo de sección circular de Ø 127 mm; de 7,80 m, 9,40 m y 11,80 m de altura, de dos tramos de sección circular superior de Ø 127 mm e inferior de Ø 152 mm o Ø 168 mm.



Installation and maintenance

Accessories to adapt it to various poles, structures and surfaces. The pole is fixed using a concrete cube, with groove for wiring, made on-site and four pole anchor bolts, 20 cm below the pavement surface. Delivered in two parts: floodlight and accessories; or three parts: floodlight, accessories and pole. Instructions, screws, template and pole anchor bolts included.

Floodlight: 6,5 kg

Instalación y mantenimiento

Adaptación a distintas columnas, estructuras o superficies mediante accesorios. Fijación de la columna mediante un dado de hormigón, con ranura para conexión eléctrica, realizado in situ y cuatro pernos de anclaje para columna, 20 cm por debajo de la cota de pavimento. El elemento se suministra desmontado en dos componentes: proyector y accesorios; o tres componentes: proyector, accesorios y columna. Instrucciones, tornillería, plantilla y pernos de anclaje incluidos.

Proyector: 6,5 kg

Arne lighting is compatible with Latina, Sara, Rama, Candela, Slope and Tumbler.



Gare de Dakar, Senegal



Sainte-Suzanne, Réunion



First Street Napa, CA, USA



Port de Soller, Mallorca, Spain



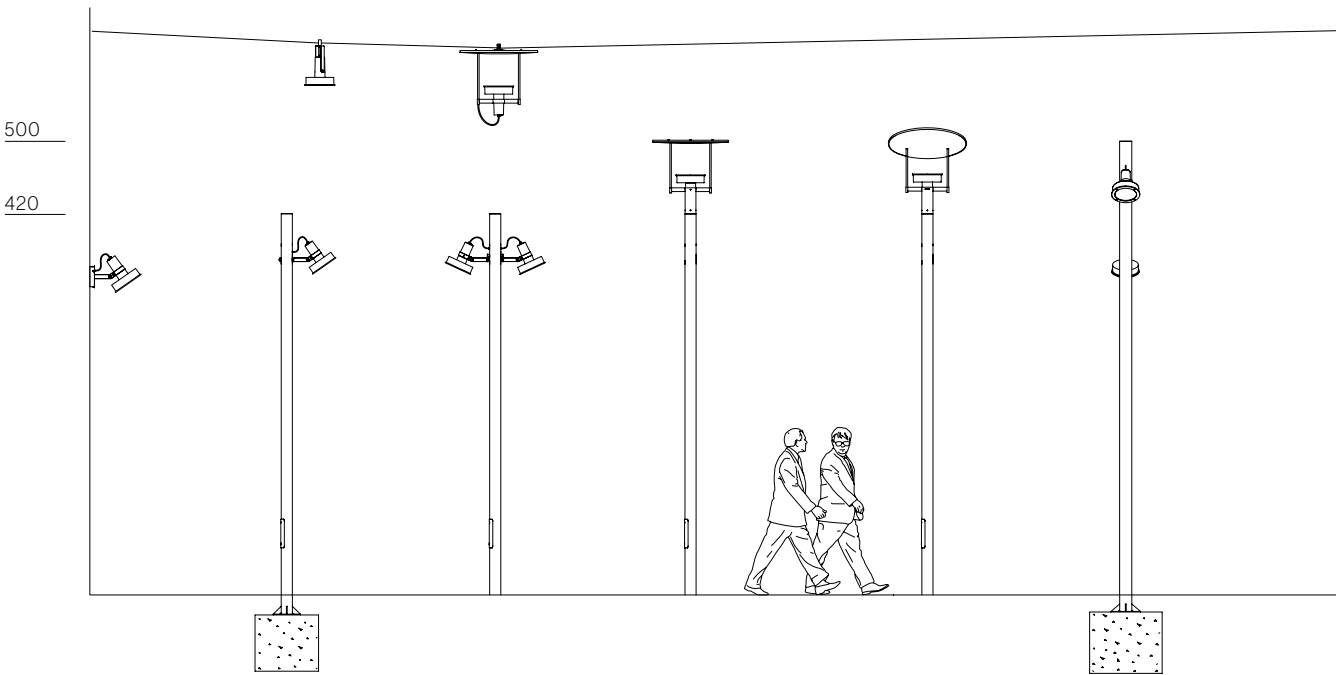

CE RoHS  IP 66 IK 08 

SYMMETRICAL

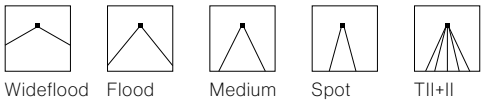

ASYMMETRICAL

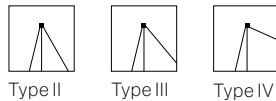

INDIRECT

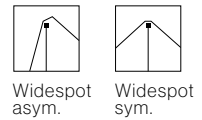

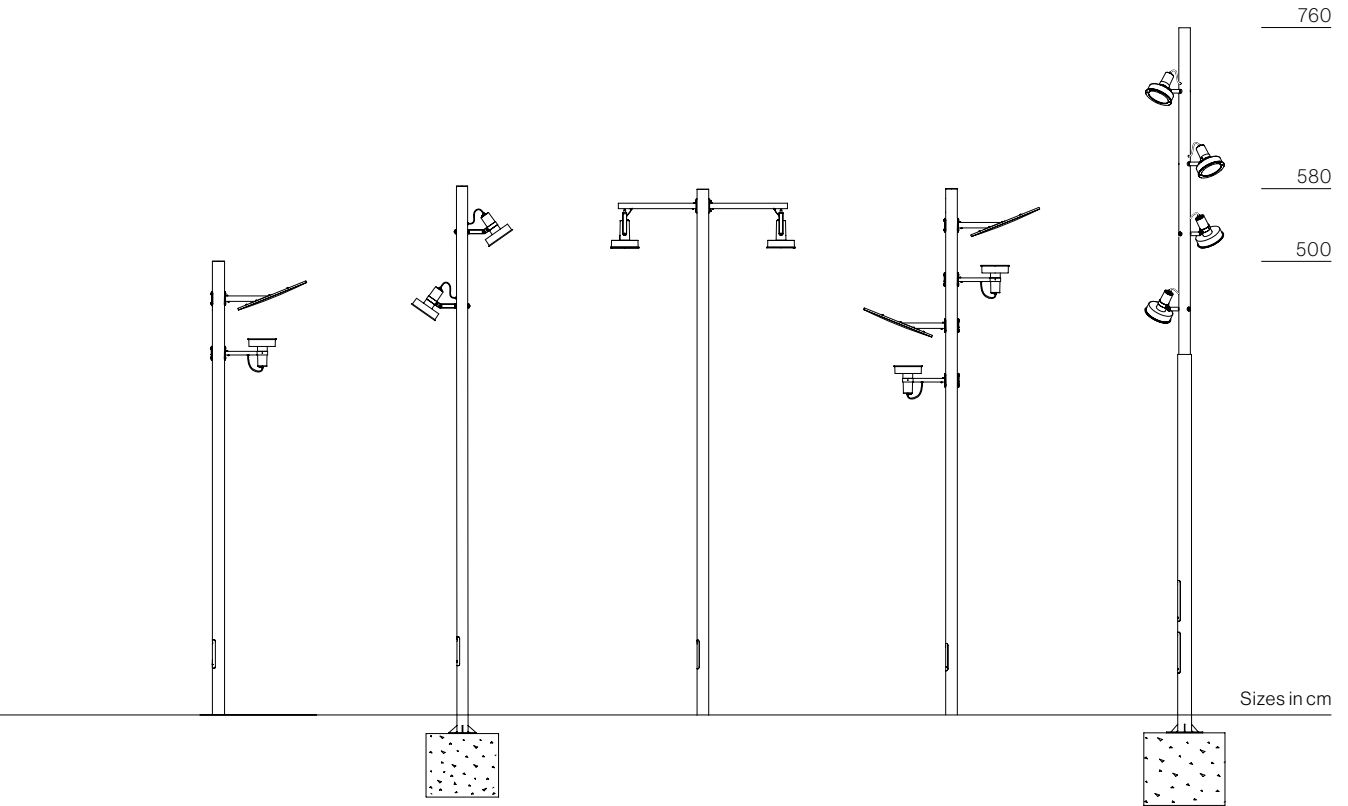

Sizes in cm

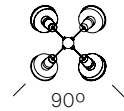
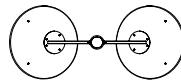
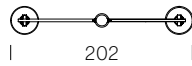
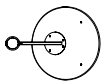

| 83 |

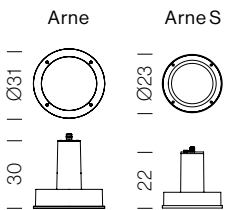

18 LEDs 22W, 32W, 42W
 36 LEDs 40W, 59W, 85W
 3000K - 4000 K
 Dimmable, see p. 347
 Updated information:
urbidermis.com

920

760

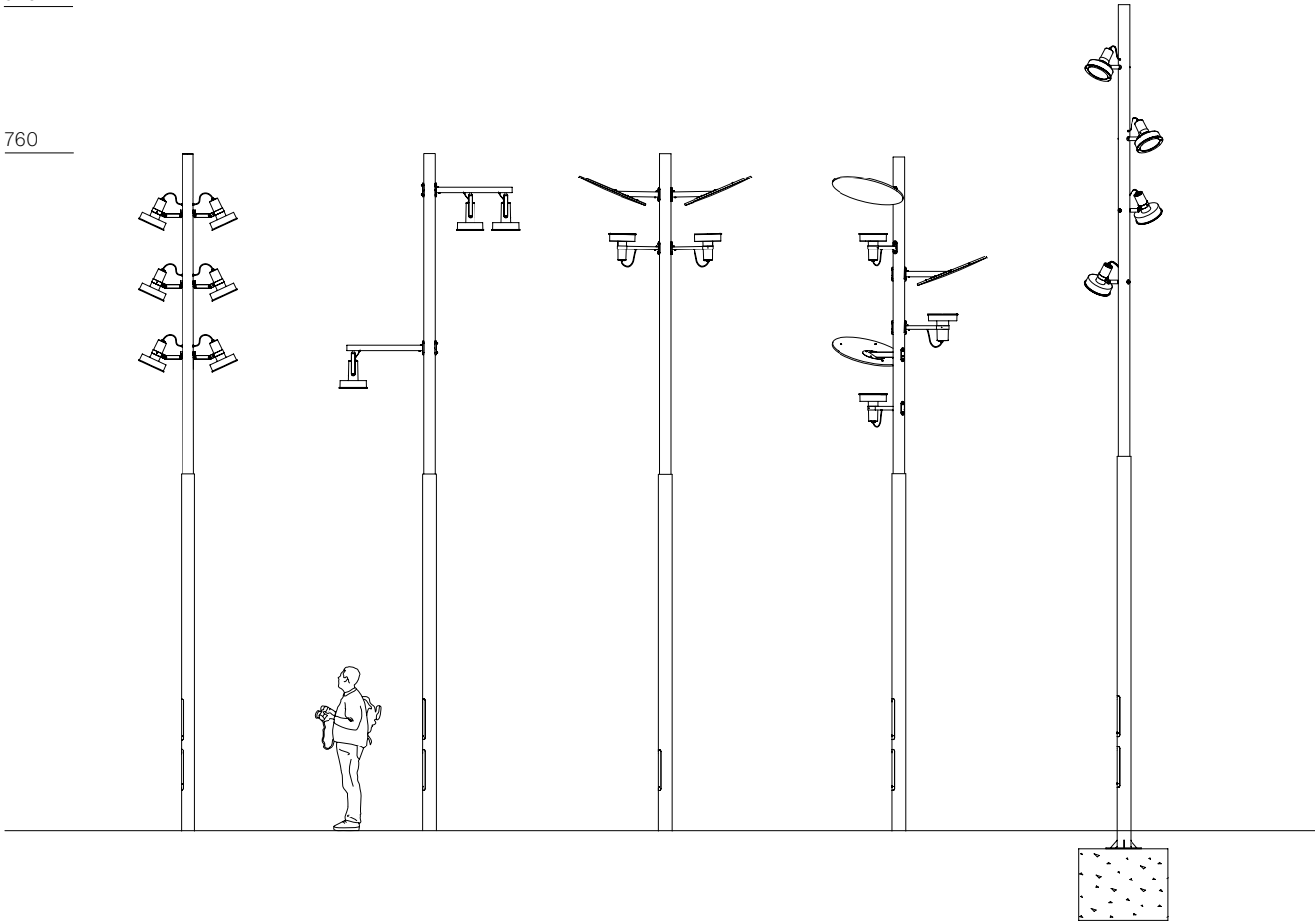

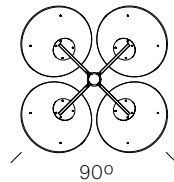
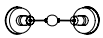
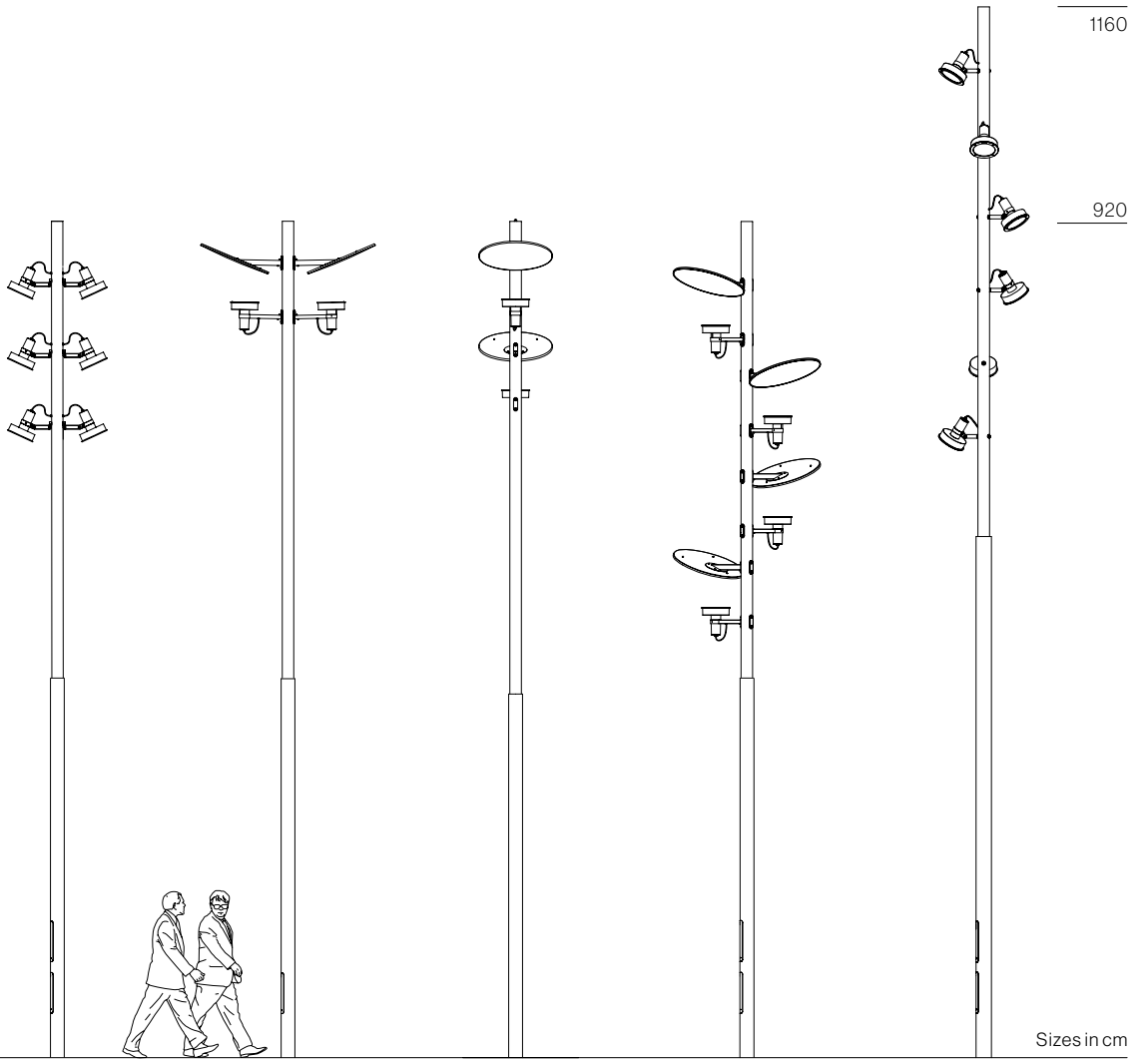

| 165 |

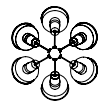



Centre Commercial Génipa, La Martinique



